

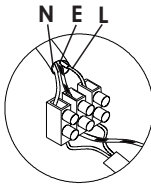

Please read instructions before commencing installation and retain for future reference.

SPECIFICATIONS:

- **Fitting:** ALUMINUM +ACRYLIC
- **Lamp type:** LED 8W 3000K
- **Protection against electric shock:** CLASS I,. Requires earth connection.
- **Ingress Protection:** IP20. Protection against entry of solid objects greater than 12mm in diameter.
- **Quality/Corrosive rating:** QC21: Burning period: 12hrs/24hr cycle. Commercial use, indoor mainly - painted or plated metals. Not for use in corrosive environments.
- **Driver:** Included.



Connecting the Terminal Block

Connect main supply (brown - live, blue - neutral, green/yellow - earth) into terminal block making sure all connections are tight.

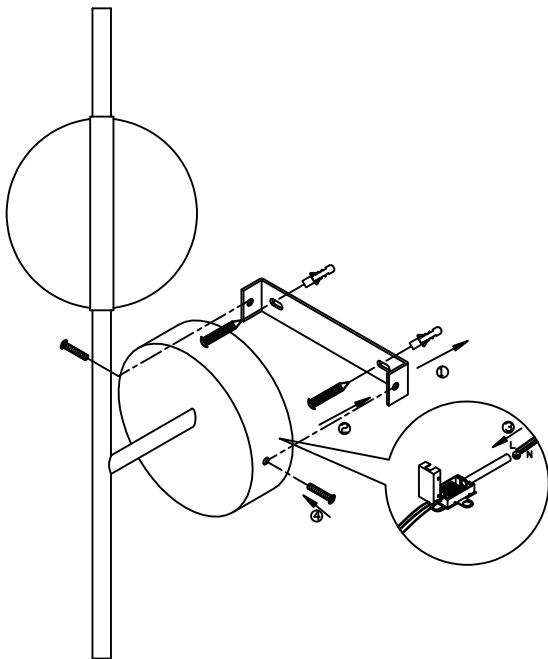

INSTALLATION INSTRUCTIONS:

⚠ Electrical products can cause death, injury, or damage to property. Installation of this product must be carried out by a qualified electrician.

- Ensure mains supply is switched off.
- Insert masonry plugs into mounting surface.
- Fit mounting bracket onto mounting surface with self-tapping screws.
- Connect wires according to color (White to White, Black to Black). Connect all earth lug together onto the crossbar with green screw to tight.
- Fit ceiling plate onto mounting bracket with nuts.
- Reconnect power.

WARNING:

- Not for outdoor use or in wet conditions.

